

OCULUS Keratograph 5M Topographer





OCULUS Keratograph 5M

Topographer

The multi-purpose topographer has become an integral part of the ophthalmological and optometric practice. Examiner-independent measurements provide reliable data, clear analyses and full documentation. Clear and easy-to-understand representations facilitate communication with your patients and ensure a time-saving workflow.

"The Keratograph 5M is one of the most versatile instruments that we have in our practice. It is highly valuable and efficient for a very busy and technology-driven eye care practice such as ours."



Barry Eiden, OD, USA

"I use the R-Scan for contact lens fitting and documentation of ocular changes – what a helpful visual consultation tool!"



(FH) Marc Schulze, PhD, Dipl. Eng., Canada

"The information that I get from this instrument plays a very important role in the fitting of all forms of rigid gas-permeable contact lenses, as well as, the simple fits of everyday soft lenses."



Chris Eksteen, DipOptom, South Africa

"The Keratograph – with easy handling when it comes to performing meibography and excellent quality images really won me over!"



Elisabeth Messmer, MD, Germany

"In my clinic we use the automated pupillometry of the Keratograph for more accurate diagnosis of mild concussions. The examination takes one minute to complete. One minute for clinicians to reduce neuropsychological problems among athletes."



Rolando Toyos, MD, USA

"I use the Keratograph imaging tool to assess the fit of contact lenses without any additional fluorescein!"



Sebastian Marx, Dipl. Eng., Germany

OCULUS Keratograph 5M – The Allrounder

Measurements With Placido Ring Illumination

White ring illumination is used to measure thousands of points on the entire corneal surface. Infrared ring illumination is also available for analyzing the tear film in order to prevent reflex tear secretion caused by glare.

LED Measurements

The Keratograph 5M proudly offers the perfect illumination for each function: White diodes for tear film dynamics, blue diodes for fluorescein images and infrared diodes for meibography.



> white illumination



> infrared illumination



> blue diodes

Where to find?

- Precise measurement of the corneal shape
- Extensive analyses and graphics
- Topographic keratoconus screening

- Course of disease displays
- Image and video documentation
- Measuring instruments

- Selection of contact lenses
- Fluorescein image simulation
- OxiMap®

- JENVIS Pro Dry Eye Report
- Tear film analysis
- Meibography
- Classification of redness

- Software overview
- Network connection ability
- Technical data

Topography

Documentation

Contact Lens Fitting

Dry Eye Screening

Technology & Software

Topography

Quick, precise and clear

Aside from topography and topographic keratoconus screening, the Keratograph 5M provides a large contact lens data base and many analyses for daily practice. The built-in keratometer and automatic measurement ensure the utmost accuracy and reproducibility. After completing the measurement, the overview display provides a detailed outline.

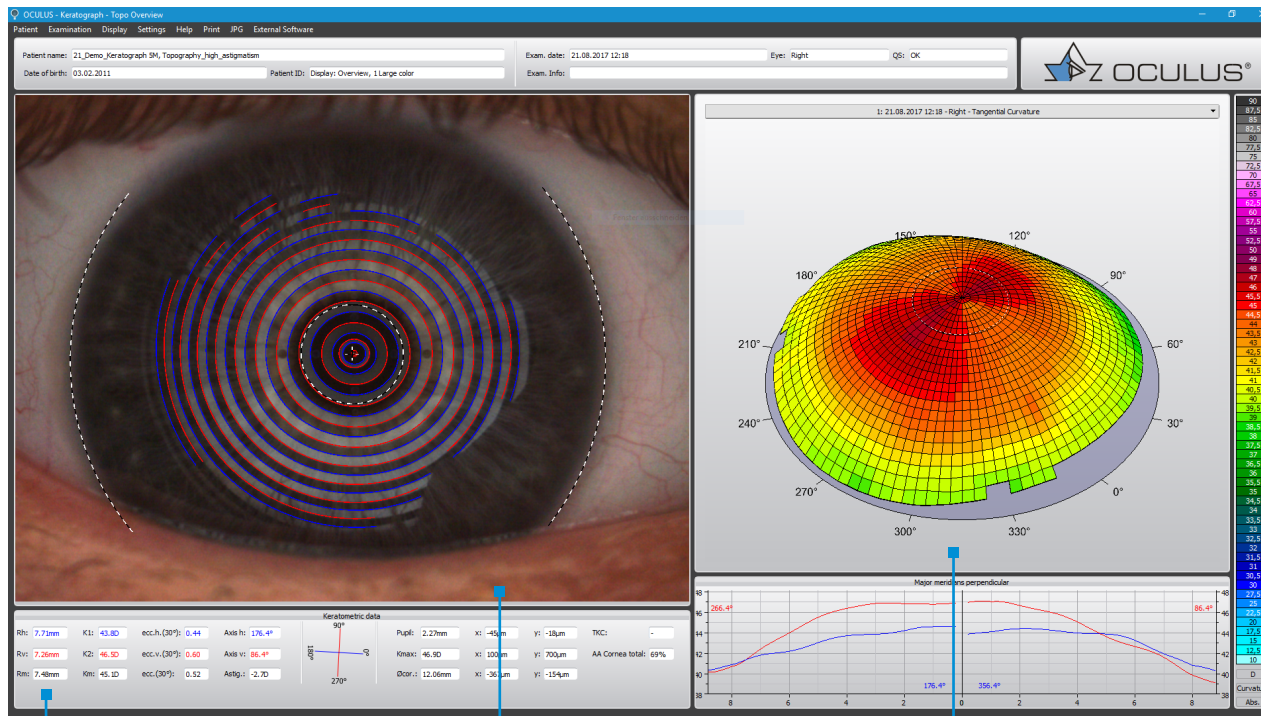

Keratometric data, diameter of the cornea and pupil, K-values and topographic keratoconus classification index, as well as asize of the analyzed surface

Built-in measuring instrument for measurements in the camera image

3D view can be selected and displayed directly beside the camera image

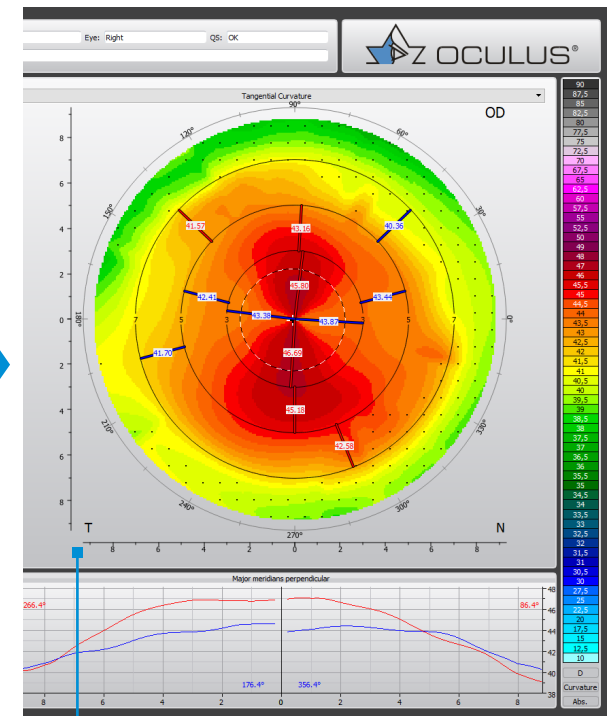

Display as sagittal or tangential curvature, elevation data or refractive power, overlay of apex position, pupil centre and contour, numerical values and major meridians

Detailed Display of the Cornea

The Keratograph software includes a reliable screening package for corneal disease detection, lens fitting and refractive surgery. The complex corneal surface structure is measured by means of mathematical analyses, which serves as the basis accurate detection of irregularities like keratoconus. In addition, optical properties of the front surface of the cornea are exactly characterized.

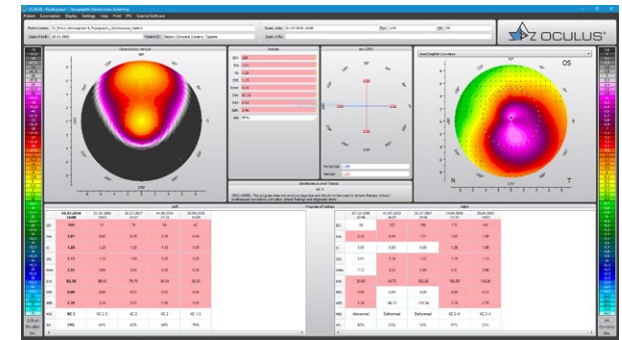
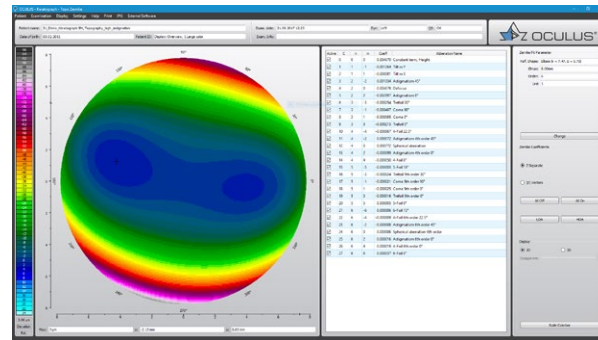
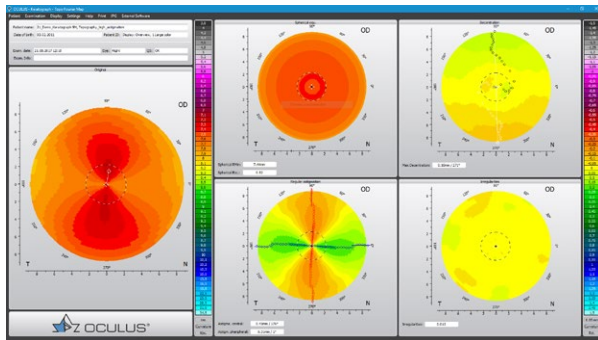

Fourier Analysis

The refractive power of the front surface of the cornea consists of different components. The Fourier Analysis identifies four of them which are shown in the following displays:

- Spherical component
- Decentration
- Regular astigmatism
- Irregularities

Pathological changes can be quantified and possible effects on visual acuity can be explained.

Zernike Analysis

Zernike polynomials are adapted to the elevation data of the cornea, which is crucial for locating the apex. The apex position is labelled with a cross. This display shows you if a back toric lens is applicable to the particular case. Zernike polynomials and the aberration coefficient give you important indications of the imaging quality of the corneal surface. Abnormal values are marked in colour.

Topographic Keratoconus Screening

Keratoconus classification is based on numerous parameters. The Topographic Keratoconus Screening display merges these parameters. The coloured label illustrates abnormal values. Temporal changes of the parameters are shown side by side in a table, to facilitate your follow-ups. The Amsler classification system is applied to the keratoconus domains.

Complete Documentation

Follow-ups provide reliability

Follow-ups require comparison of several examinations. In doing so, changes can be easily detected and fully documented. Regular follow-up examinations provide reliability and increase the trusting relationship between you and your patient. The Keratograph software contains both data and image documentation.

Comparing Examinations

With the new Compare 4 Exams display you can now compare up to four examinations. Changes from the first to the latest measurement can easily be displayed, reflecting the course of disease over time. Select the examination that you wish to compare (A, B, C, D) with only two clicks and see the results right away – independently of the curvature type. The easy-to-understand display helps you describe even complex matters to your patient.

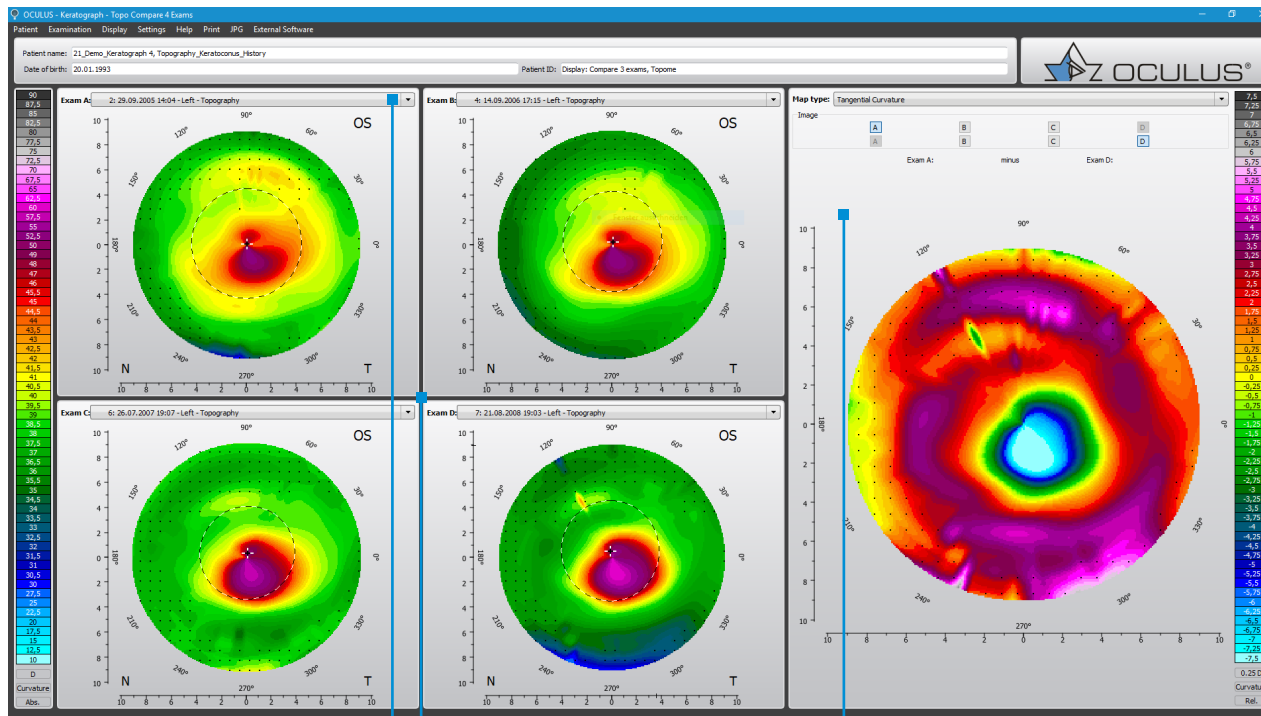

Selection of examination from the patient data base

"Course of Disease" display showing four examinations

Graphic display of differences between individual examinations. Display as axial/sagittal or tangential curvature, elevation data or refractive power.

A Picture Is Worth a Thousand Words.

The Keratograph 5M contains features that offer optimal conditions for your image documentation such as the high-resolution colour camera and different illumination options. An image aids in communication with education of your patients, thus eliminating the need for long explanations. You save time with only one mouse click.

NEW The Keratograph 5M comes equipped with a wireless joystick including a release function. Capture images and video sequences with a single push of a button!

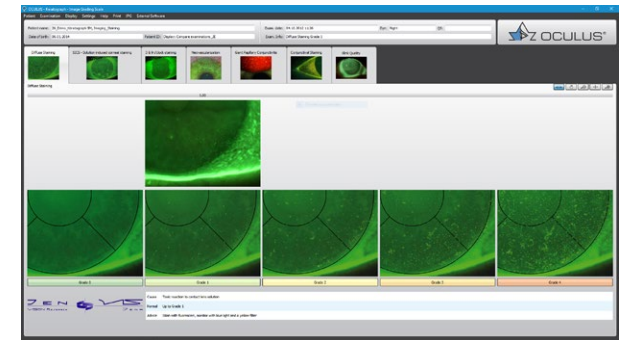
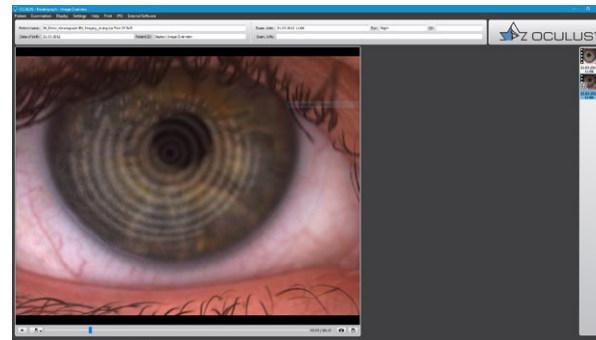
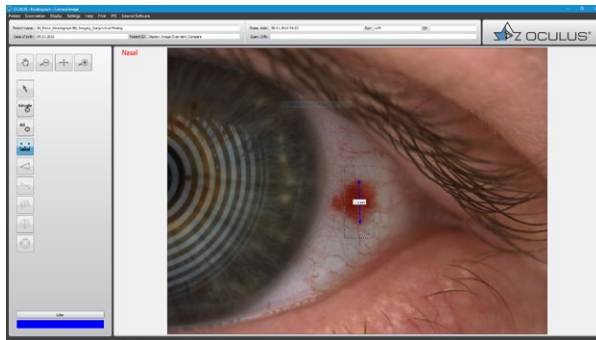

Precise Measurements Instead of Rough Guesses

The Keratograph 5M is the ideal device for your professional documentation. The imaging software includes features such as

- magnification function
- hand tool
- measuring tool
- angle measurement

Pathological changes can be exactly localized, and changes in size can be determined. This ensures that all of your patients questions will be answered.

High-Resolution Images

You can evaluate the wettability of contact lenses, without fluorescein application and determine the exact rotating of toric lenses. It is also possible to detect lipids and deposits on the lens surface, as well as corneal staining or vascularization. Show your patients images they have never seen before.

Reliable Diagnosis Documentation

The resulting classification from corneal staining requires well-trained examiners. It is difficult to estimate the number of hyper-fluorescent dots on the corneal surface, but the integrated JENVIS Grading Scales facilitates this evaluation. Every image taken can be compared with a sample image on the screen. Vessel injections can also be evaluated and documented in this way.

Contact Lens Fitting

Professionalism through innovation

An ideal lens is chosen from the large lens data base and is then suggested in the Lens Fitting display. Based on this topographic data, a simulated fluorescein image of this particular lens is created. You can then take real fluorescein images with the Keratograph 5M and compare them with the simulated images.

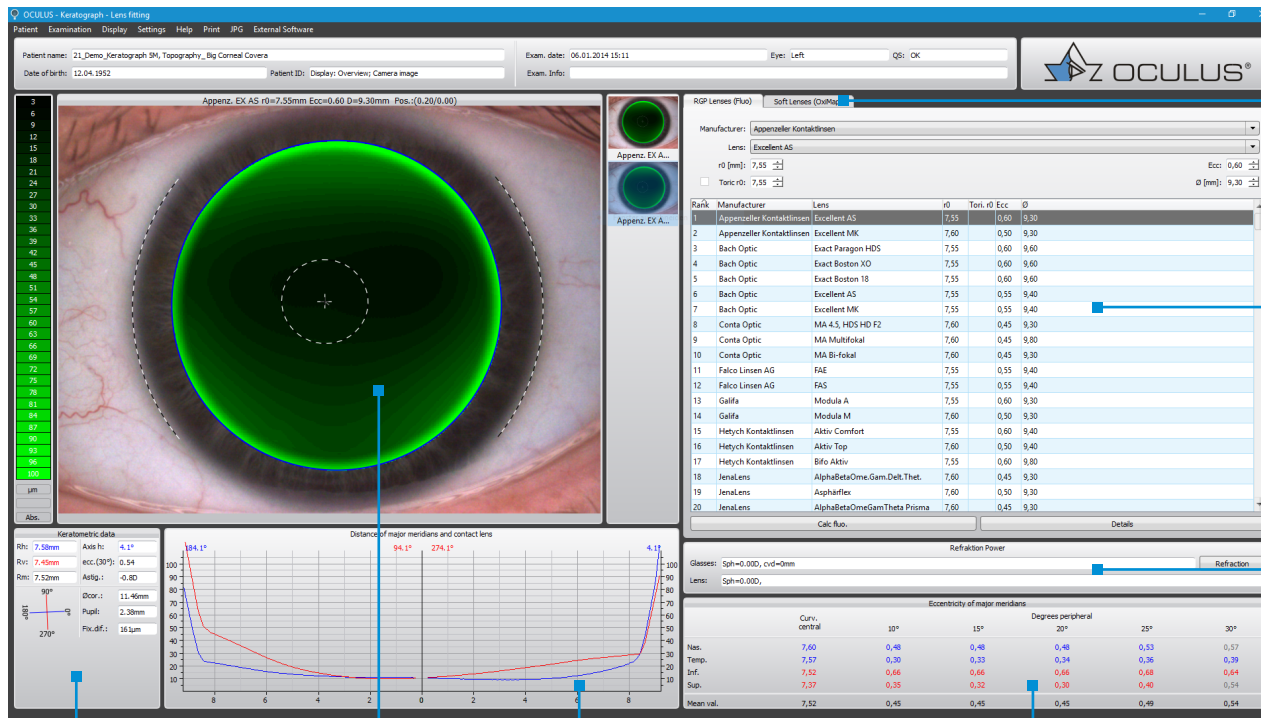

Selection between RGP and soft lenses

Contact lens suggestion from the large data base

Subjective refraction data and CVD conversion

Keratometric data, diameter of the cornea and pupil, fixation deviation

Simulated fluorescein image of a toric RGP lens

Distance of major meridians of the cornea from the lens

Eccentricity values for both major meridians

Multifocal, Bifocal, Toric

With the Keratograph 5M you can quickly and precisely measure all of the data needed for multifocal, bifocal and toric contact lenses. These measurements also facilitate the fitting of multifocal or bifocal lenses. Furthermore the Keratograph 5M software can be linked to fitting programs of various contact lens manufacturers.

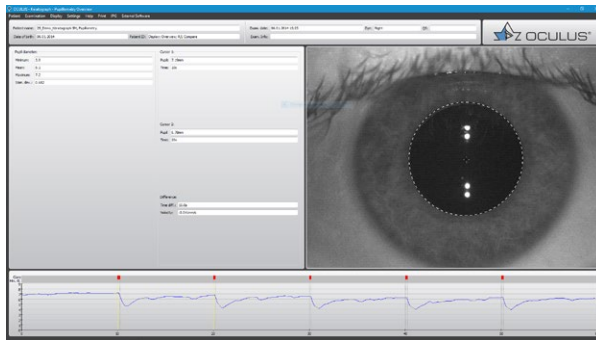

Pupillometry

Using the "Pupillometry" option is a quick and easy way to measure the pupil size of your patients under different illumination conditions. This option not only supports you when fitting multifocal lenses, but also when measuring the optical zone before refractive or cataract surgery.

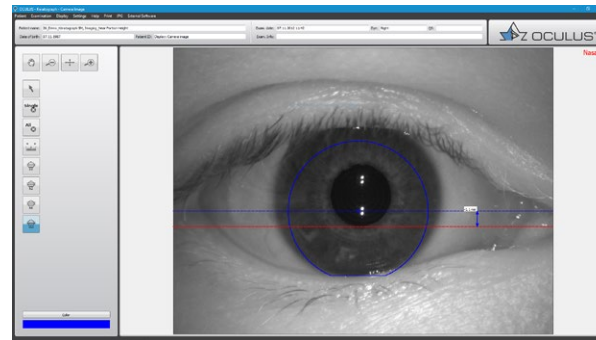

Near-Portion Height Measurement

The near-portion height of RGP bifocal lenses can be simulated and precisely determined with this software, even before ordering the first trial lens. This also facilitates the complex fitting of multifocal lenses.

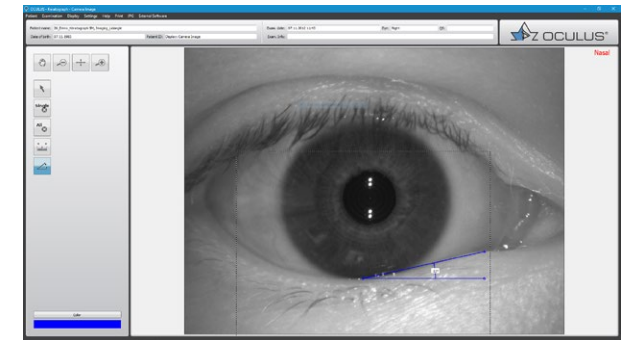

Palpebral Angle Measurement

The imaginable angle of the nasal side of the lower eyelid can be measured to determine the expected nasal rotation when fitting lenses for astigmatism.

OxiMap®

Visualizing the oxygen transmissibility of soft lenses

An intact tear film and good oxygen supply to the cornea are essential for comfortable lens wear. The OxiMap® displays the oxygen transmissibility of soft lenses in different colours depending on the optical power and is easy to understand – even for your patients.

Influence of Contact Lens Wearing Time

The oxygen transmissibility is an important quality criterion of soft lenses. It is indicated as Dk/t value and has a significant influence on the recommended lens wearing time. The higher the Dk/t value, the more oxygen gets through the lens to the cornea. Oxygen transmissibility changes depending on the material and the optical power of the lens.

Only measurements of oxygen transmissibility in the centre of a lens with -3.00 D have been demonstrated thus far. For the first time, the OxiMap® integrated in the Keratograph 5M displays Dk/t values over the entire surface depending on the contact lens power. You choose the lens type and the respective power. The OxiMap® is projected onto your patient's eye and you can immediately see if the selected lens is suitable for wearing overnight, for example. Explain to your patient the advantages of modern contact lenses.

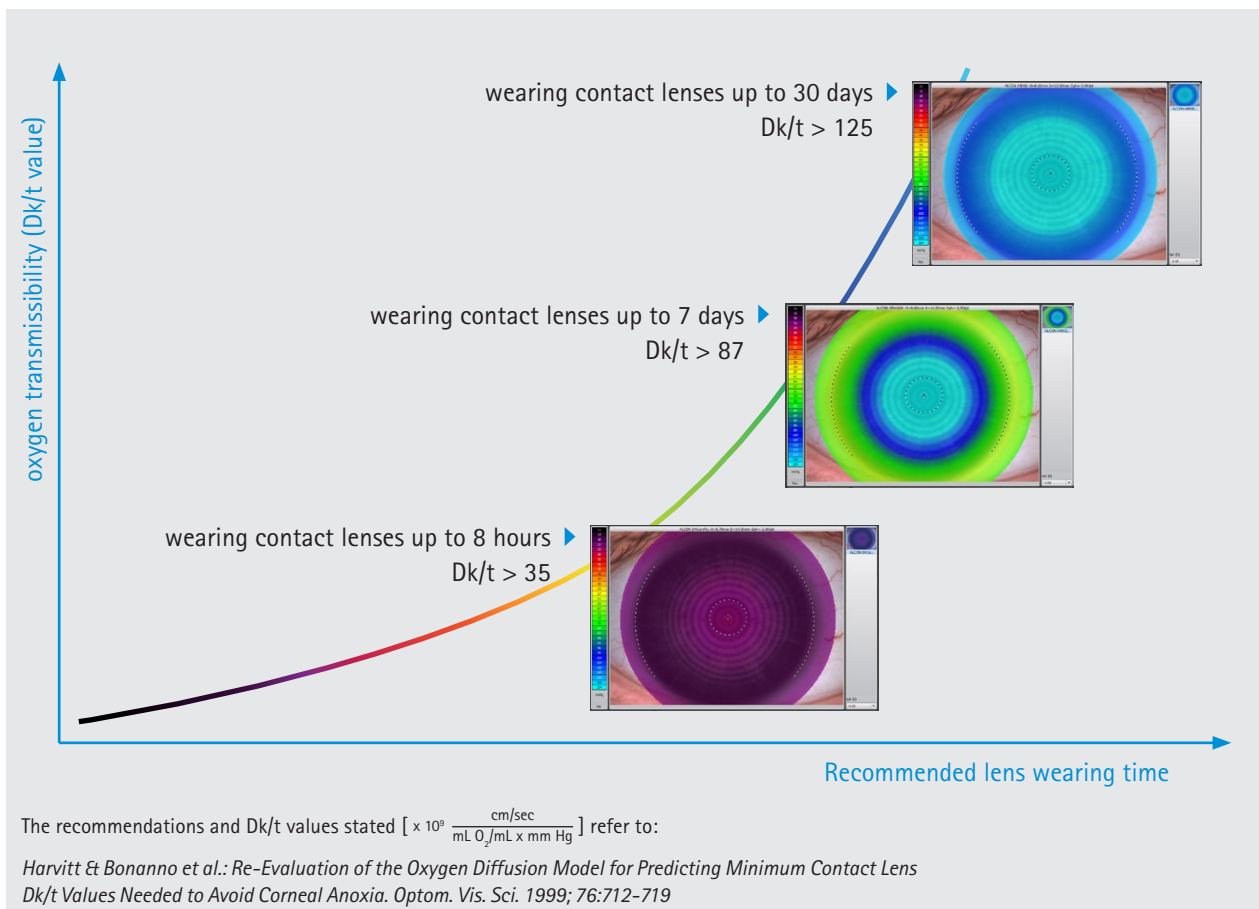



Topography

Documentation

Contact Lens Fitting

Dry Eye Screening

Technology & Software

NEW JENVIS Pro Dry Eye Report

Combine Screening with Counselling

Find the cause of dry eye syndrome quickly and reliably. The new JENVIS Pro Dry Eye Report in the Keratograph 5M will help you as you go along. Perform a comprehensive screening, using the measuring results as a basis for diagnosing dry eye syndrome. All results are documented in accordance with the Medical Products Law and summarized for your patient in a neat and easily understandable printout.

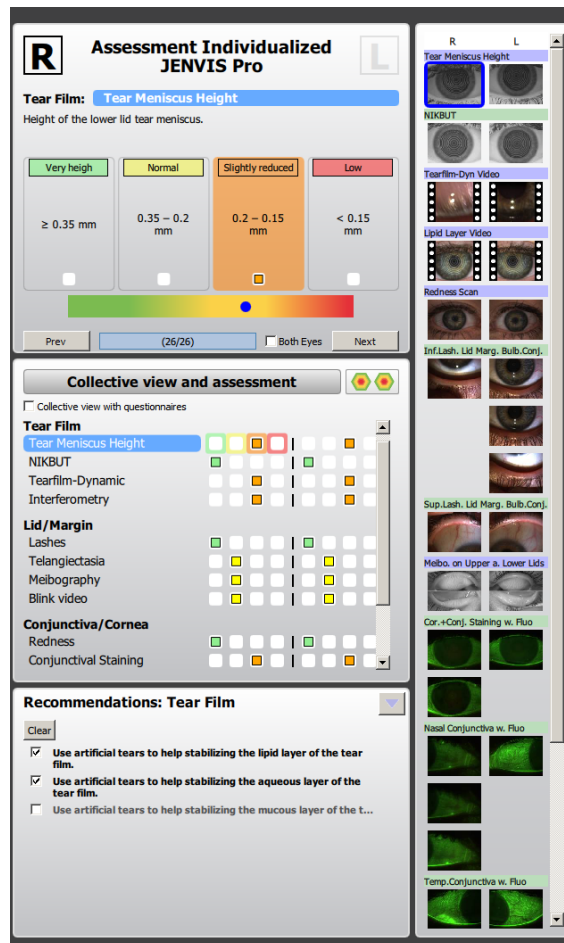

- ✓ **Quick**
The optimized workflow is time-saving and patient-friendly.
- ✓ **Simple**
Having a complete overview of measurements makes selecting images for the analysis extremely easy.
- ✓ **Easy to understand**
Image material is also important for counselling patients. Pictures say more than a thousand words and they will make educating your patients a breeze.
- ✓ **Supportive**
Management of dry eye syndrome calls for discipline in patients in continuously adhering to professional advice given.
- ✓ **Easy to follow**
To provide a guideline to follow, simply tick the relevant recommendations, print them out for your patients to take home and schedule a follow-up appointment.

JENVIS Pro Dry Eye Software – The Dry Eye Analysis Tool

Make use of all the advantages of the new JENVIS Pro Dry Eye Report in the Keratograph 5M: efficient screening, well-founded measurement results and greater patient loyalty.

Screening for dry eye syndrome should be a routine part of every refraction.

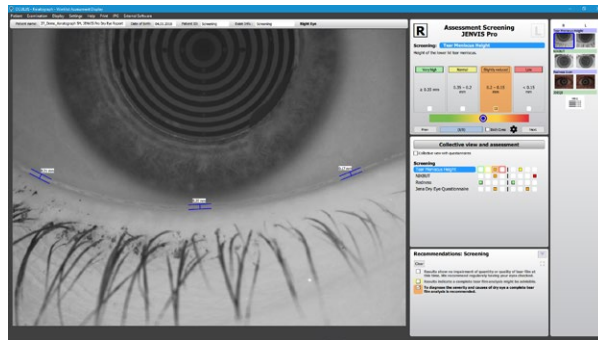

Screening for a quick overview

The four-part screening test quickly and accurately reveals abnormalities in tear film quantity and quality. This 5-minute screening should be carried out routinely before every refraction. The JENVIS Pro tear film screening routine includes measurement of the tear meniscus height, tear film break-up time, bulbar redness and a short questionnaire.

Make a quick and easy decision whether your patient has dry eye symptoms.

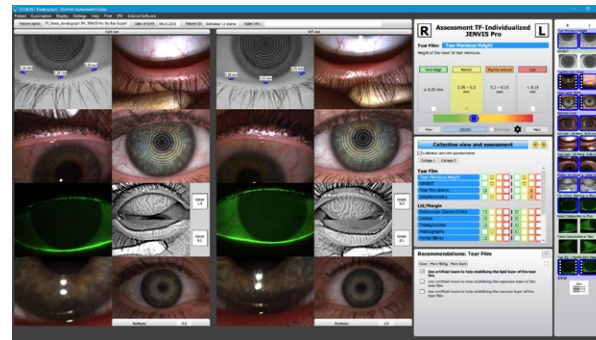

Individualized – impressive and complete

The JENVIS Pro Dry Eye Report provides you with a fail-safe test sequence covering all the assessment criteria required for a comprehensive analysis for dry eye syndrome. It provides you with useful hints and optimized, predefined settings to support you in your measurements, enabling you to perform a quick and efficient analysis for dry eye syndrome and document your anterior segment findings.

Get equipped to give your patients specific advice for easing their dry eye symptoms.

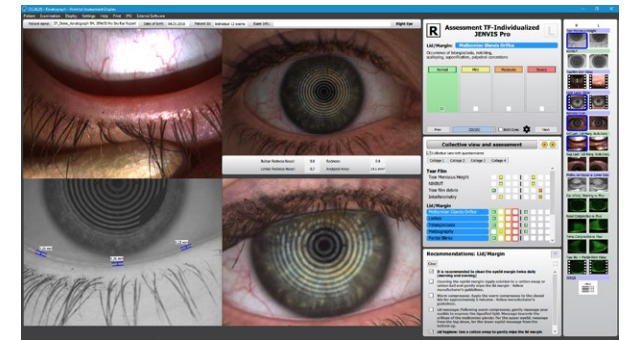

Follow-up – retain customers by monitoring their success

You want to know whether your treatment recommendations have been successful? Then use the follow-up function with its setting options for characterizing the initial cause. This will enable you successfully document improvements in your patients' tear film condition.

Regular check-ups will make you the go-to specialist for your patients.

TF-Scan

Evaluation of non-invasive tear film break-up time

The non-invasive Keratograph tear film break-up time (NIK BUT) measures tear film stability. The NIK BUT is automatically measured within seconds, without fluorescein application. Human eyes are not able to perceive infrared illumination. Glare and reflex tear secretion are therefore avoided during the examination. The TF-Scan visualizes the results in an easy and understandable way – for you and your patients.

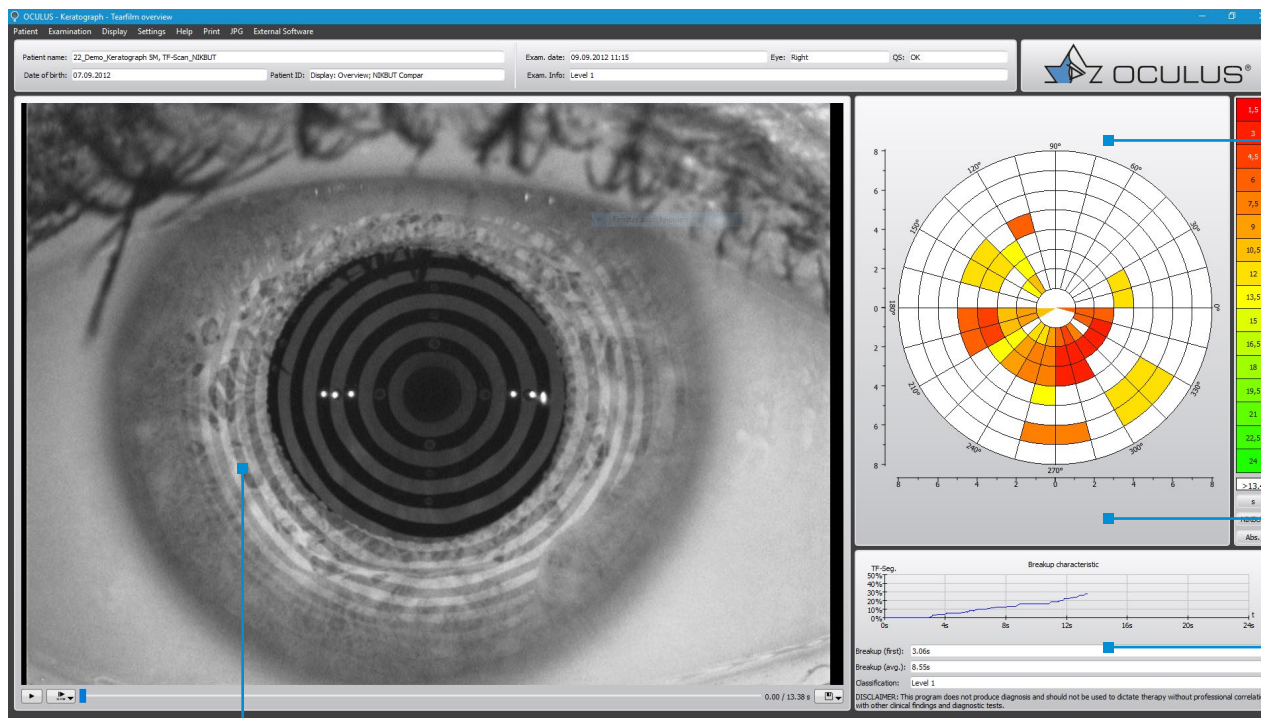

The Tear Map shows the affected areas: The respective break-up time is graphically illustrated for each segment in seconds and according to the principle of a traffic light.

The graph shows percent of the examined area that is affected during the measuring period.

Data field showing tear film break-up time (NIK BUT) in seconds and the corresponding classification.

You can watch the video after the measurement. The break-up areas detected by the software are highlighted accordingly.

Quantity and Quality of the Tear Film

The high-resolution colour camera makes the smallest structures visible. This enables you to measure the tear meniscus height and evaluate the lipid layer, as well as analyse the tear film dynamics. Not only do you gain very important findings about tear film break-up time, but also those about the quantity and quality of the tear film.

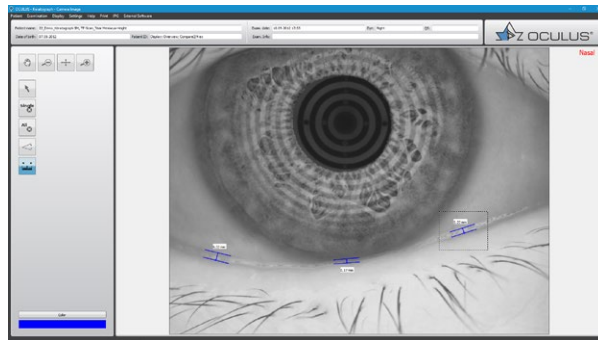

Tear Meniscus Height

Never has a precise measurement been so easy. You can evaluate the course of the tear meniscus along the eyelid by means of the new infrared illumination and precisely measure the tear meniscus height with the built-in ruler. Different magnification levels facilitate measurement and the resulting value is automatically saved in the patient file.

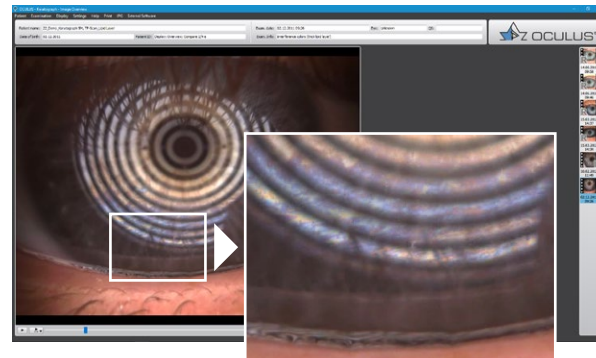

Evaluation of Lipid Layer

Hyper-evaporative dry eye is easily overlooked when using conventional tests. Thus evaluating the lipid layer of the tear film is even more important. With the Keratograph 5M you can record videos of interference patterns of the lipid layer. Distribution characteristics, morphology and thickness of the lipid film can be continuously evaluated.

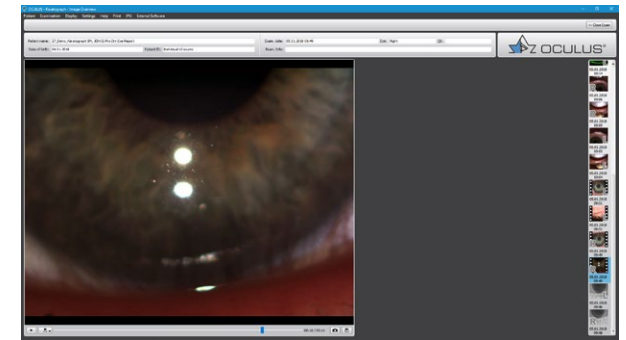

Tear Film Dynamics

The tear film contains numerous particles. These can be made visible using a specific light source. These particles are distributed in the tear fluid from bottom to top during each blink. The velocity of these particles provides information on tear film viscosity. You can quickly and easily evaluate the quantity and movement of these tear film particles using the TF-Scan.

Meibo-Scan

Meibography of the upper and lower eyelid

With the multi-functional Keratograph 5M even difficult examinations such as meibography become simple to perform. It makes it easy to visualize meibomian gland dysfunction (MGD), the most frequent cause of dry eye disease. Morphological changes in the glandular tissue of the upper and lower eyelid are displayed. Up to four images from examinations of the same eyelid can be compared in a single display to assess the patient's progress.

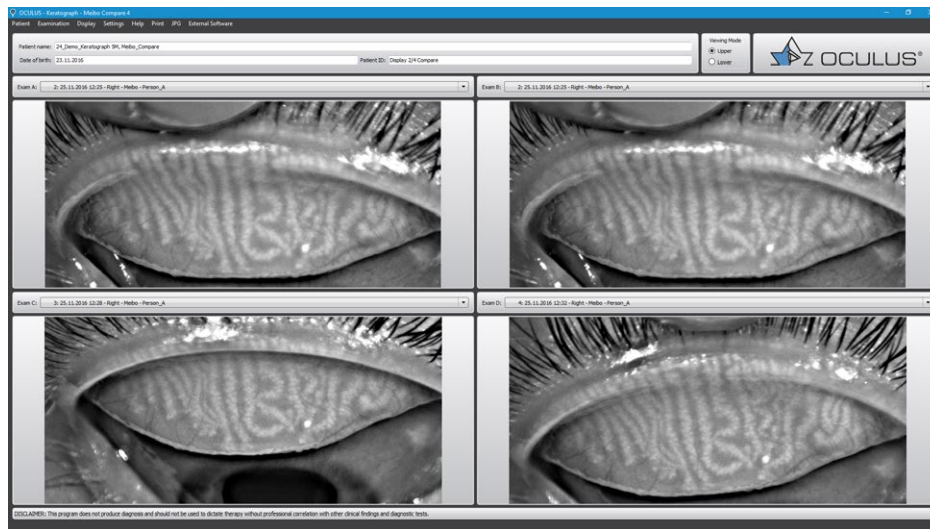

Intuitive Comparison of Meibography Findings

The "Compare Meibo Exams" function makes it possible to assess the condition of the glandular tissue over time and hence the success of treatment. It is also helpful in communicating with and educating patients.

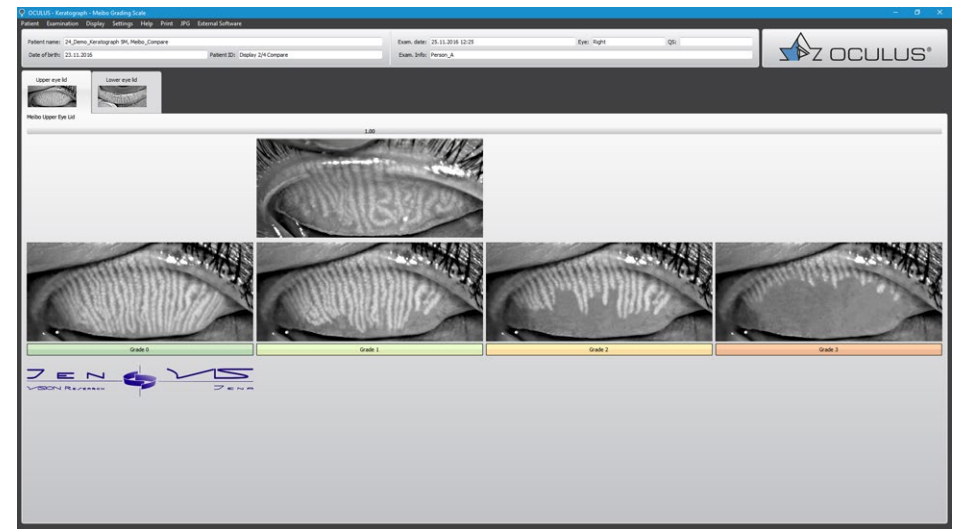

JENVIS Grading Scales

These four-point grading scales allow easy classification of MGD based on an individual meibography. Reference-state images assist in classifying the gland structure as normal or indicative of mild or severe MGD.

R-Scan

Automatic classification of conjunctival redness

Previously conjunctival redness evaluation has been carried out subjectively and the results have varied according to the examiner's qualification. It is possible to objectively classify bulbar and limbal redness completely and automatically using the R-Scan. The R-Scan detects vessels in the conjunctiva and evaluates the degree of redness. Automatic classification eliminates the need for time-consuming comparison and provides greater reliability during evaluation.

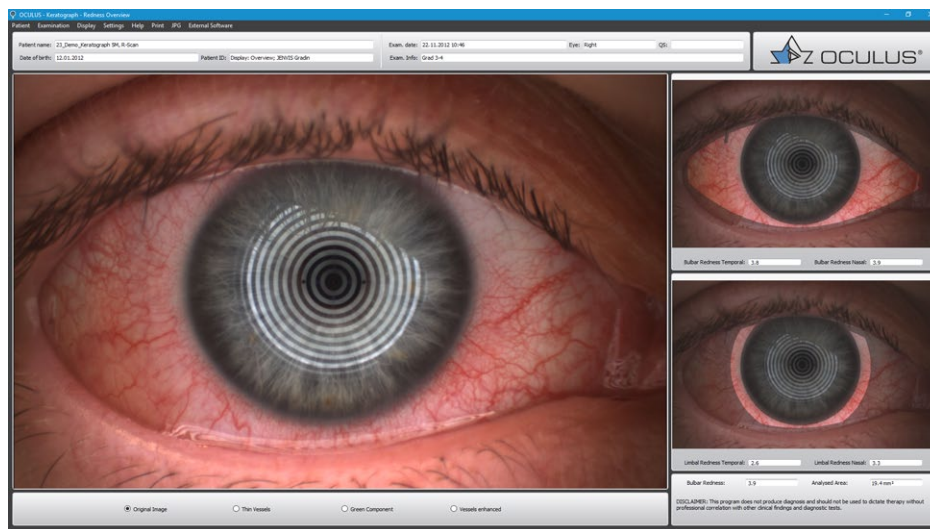

Bulbar and Limbal Redness

Different display options help to classify the degree of redness. Choose between the camera image, view of fine vessels in the conjunctiva, red-free or contrast-enhanced display options. Bulbar and limbal redness are evaluated in the temporal and nasal areas and all results are saved automatically.

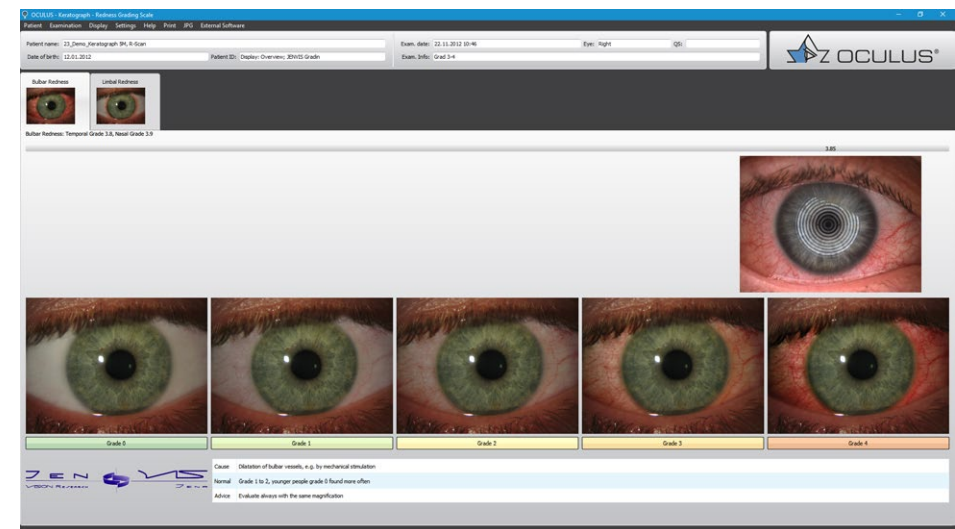

JENVIS Grading Scales

The degree of redness is based on the JENVIS Grading Scales. The comparison of your examination results with the actual-scale images of the JENVIS Grading Scales facilitates the conversation when consulting with your patient. Further information on possible causes of redness, the normal condition as well as practical notes for capturing an image are provided below the actual-scale images.

All Features at a Glance

Customize the OCULUS Keratograph 5M to your own requirements!

Standard software included

Topography
CL Back Surface
Overview
1 Large Color Map
4 Maps Selectable
Camera Image
3D Cornea
Fourier Analysis
Zernike Analysis
Topographic Keratoconus Screening
Elevation Map
Corneal asphericity
Lens Fitting
Show 2 Exams
Compare 2 Exams
Compare 3 Exams
Compare 4 Exams
Imaging

Optional software modules

JENVIS Pro Dry Eye Report

Comprehensive summary display of all available dry eye tests, including:

- TF-Scan
Evaluation of lipid layer and tear film dynamics, measurement of tear meniscus height and non-invasive tear film break-up time (NIK BUT)
- R-Scan
Automatic classification of bulbar and limbal redness
- Meibo-Scan
Meibography of upper and lower eyelid

Keratoconus package

Includes Topographic Keratoconus Screening and Zernike Analysis

Lens Fitting

Simulation of fluorescein images of RGP lenses

OxiMap®

Graphic display of oxygen transmissibility (Dk/t value) of soft lenses

Pupillometry

Examination of pupillary response using the pupillometer, asymmetry test and manual measuring mode

Floating License Key

More flexibility with the OCULUS license model

Activate Functions Exactly as You Need Them

The choice is yours in how you use the Keratograph 5M and which examination and evaluation functions you desire. You can order additional licenses of optional evaluation functions, according to your modular design principle. After purchase, licenses for the respective evaluation functions are activated on the OCULUS Floating License Key and are provided in your network. It is possible to call and view previously performed examinations for free on all workstations within the network.

Optional examination functions	Optional evaluation functions
TF-Scan*	JENVIS Pro Dry Eye Report
R-Scan*	Keratoconus package
Meibo-Scan*	Lens Fitting
Pupillometry	OxiMap®

* Not available separately

You can decide which additional functions to allocate to each device.

Efficiency Through Networking

The OCULUS patient data management system enables you to merge all OCULUS devices in a local network. It allows you to collaborate with external data management systems (EMR) to optimize your workflows. DICOM interface is not necessary for device connection.

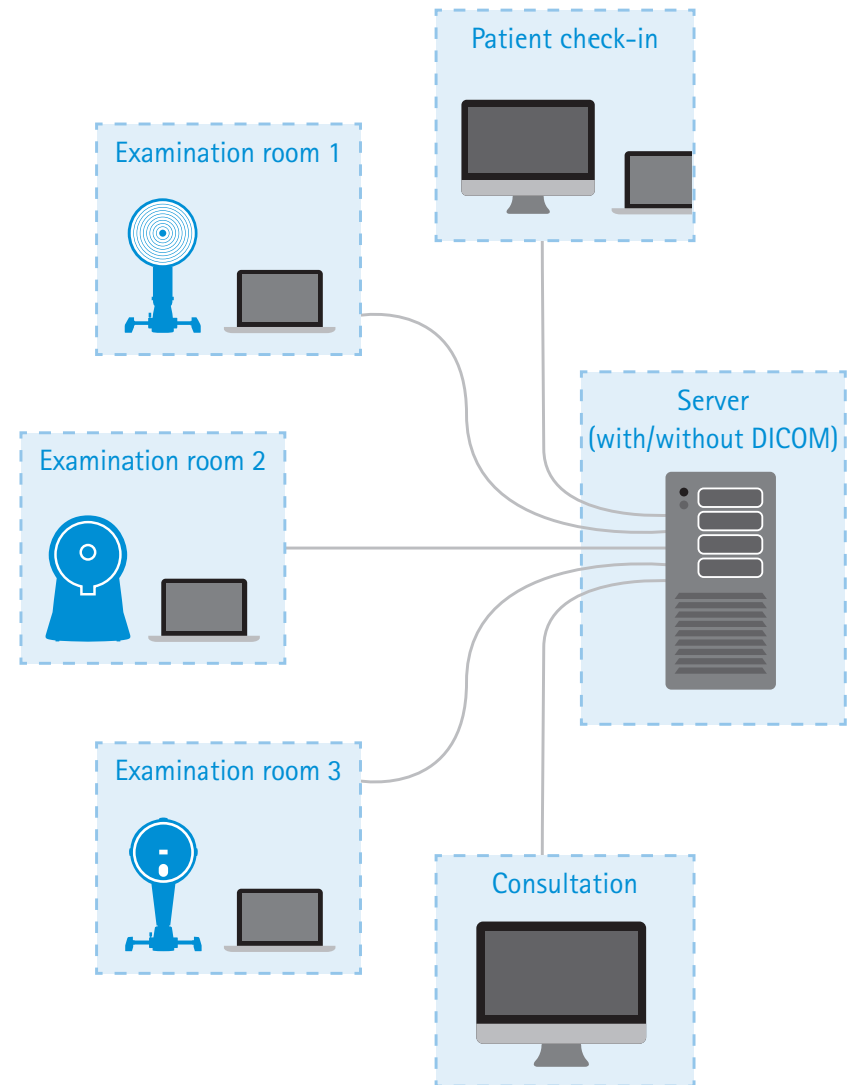

Topography

Documentation

Contact Lens Fitting

Dry Eye Screening

Technology & Software

Technical Data

OCULUS Keratograph 5M

General information	
Accuracy	± 0.1 D
Reproducibility	± 0.1 D
Number of rings	22
Working distance	78 / 100 mm
Number of measuring points	22 000
Camera	Digital CCD camera
Light source	Placido illumination: white diodes Placido illumination: infrared diodes (880 nm) Imaging illumination: blue diodes (465 nm) Meibography: infrared diodes (840 nm) Tear film dynamics: white diodes Pupillometry illumination: infrared diodes (880 nm)
Technical specifications	
Dimensions (W x D x H)	275 x 320 - 400 x 480 - 510 mm (10.8 x 12.6 - 15.7 x 18.9 - 20.2 in)
Weight	Measuring head: 3.2 kg (7.1 lbs) With xy base: 6.1 kg (13.5 lbs)
Max. power consumption	18 W
Voltage	90 - 264 V AC
Frequency	47 - 63 Hz
Recommended computer specifications	CPU Intel® Core™ i5-7600, 1 TB HDD, 8 GB memory, Windows® 10Pro

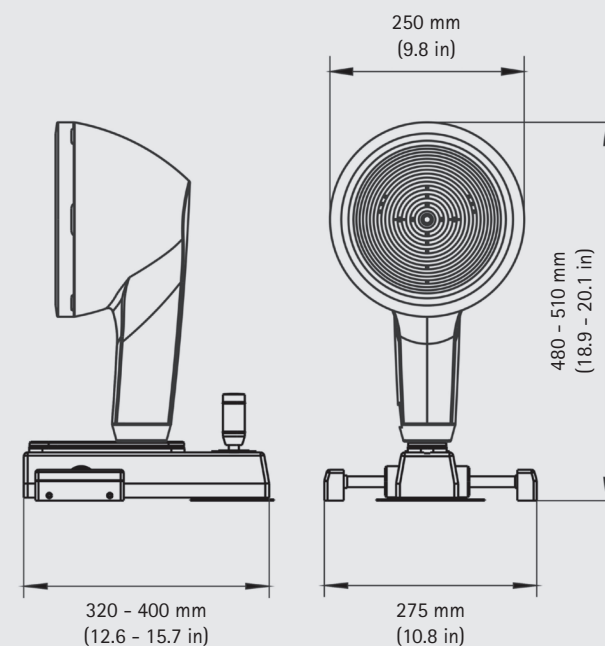

CE in accordance with Medical Device Directive 93/42/EEC

WWW.OCULUS.DE

OCULUS Optikgeräte GmbH
Postfach • 35549 Wetzlar • GERMANY
Tel. +49 641 2005-0 • Fax +49 641 2005-295
Email: export@oculus.de • www.oculus.de

- OCULUS Asia, info@oculus.hk
- OCULUS Brasil, info@oculusbrasil.com.br
- OCULUS Canada, sales@oculus.ca
- OCULUS Czechia, oculus@oculus.cz
- OCULUS Iberia, info@oculus.es
- OCULUS Turkey, info@oculus-turkey.com.tr
- OCULUS USA, sales@oculususa.com



OCULUS is certified by TÜV according to
DIN EN ISO 13485 MDSAP

The availability of products and features may vary by country.
OCULUS reserves the right to change product specifications and
design. All information is valid at the time of printing (03/19).

OC/1895/WZ/EN
P/77000/EN